

### 10.5 Fault information

- Err1 no data stored for browsing
- Err2 the Ra value of the standard sample is too small to be used for calibration
- Err3 the value is too small to continue to decrease.

### 10.6 Code Standard Name

ISO 4287	International Standard
DIN 4768	German Standard
JIS B601	Japanese Industrial Standard
ANSI B46.1	American Standard

### 10.7 Cutoff length recommended

Ra (μm)	Rz (μm)	Cutoff length (mm)
>5~10	>20~40	2.5
>2.5~5	>10~20	
>1.25~2.5	>6.3~10	
>0.63~1.25	>3.2~6.3	0.8
>0.32~0.63	>1.6~3.2	
>0.25~0.32	>1.25~1.6	
>0.20~0.25	>1.0~1.25	0.25
>0.16~0.20	>0.8~1.0	
>0.125~0.16	>0.63~0.8	
>0.1~0.125	>0.5~0.63	
>0.08~0.1	>0.4~0.5	
>0.063~0.08	>0.32~0.4	
>0.05~0.063	>0.25~0.32	
>0.04~0.05	>0.2~0.25	
>0.032~0.04	>0.16~0.2	
>0.025~0.032	>0.125~0.16	
>0.02~0.025	>0.1~0.125	

# SURFACE ROUGHNESS TESTER

This Surface Roughness Tester is small in size, light in weight, easy to carry. Although complex and advanced, it is convenient to use and operate. Its ruggedness will allow many years of use if proper operating techniques are followed. Please read the following instructions carefully and always keep this manual within easy reach.

### Square Algorithm.

#### 10.2 Central line

This tester adopts minimum central line of Least Square Algorithm.

#### 10.3 Traversing length

- $l$  = sampling length
- $n$  = number of sampling length
- $l \times n$  = evaluation length

##### 10.3.1 RC filter

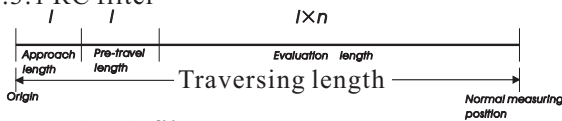

##### 10.3.2 PC-RC filter

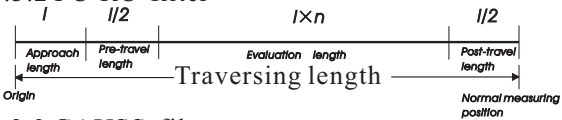

##### 10.3.3 GAUSS filter

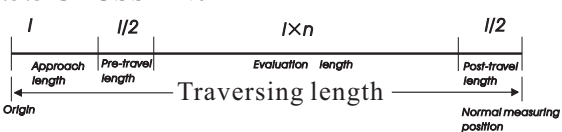

##### 10.3.4 D-P filter

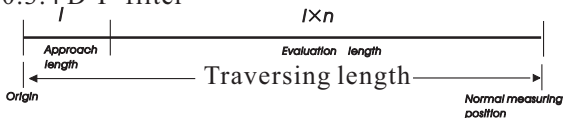

#### 10.4 Definition of roughness parameter

- 10.4.1 Ra arithmetical mean deviation of profile  
Arithmetic value of mean deviation of profile within sampling length.

\*The tester can memorize 7 groups of measurement results and measuring conditions for later use or download to PC for analysing, printing.

\*Metric /Imperial Conversion

### 2. SPECIFICATIONS

Display: 4 digits, 10 mm LCD, with blue backlight

Parameters: Ra, Rz, Rq, Rt

Display Range

Ra, Rq: 0.025-16.00um/1.000-629.9uinch

Rz, Rt: 0.020-160.0um/0.780-6299uinch

Accuracy: Not more than ±10%

Fluctuation of display value: Not more than 6%

Sensor :

Test Principle: Inductance type

Radius of Probe Pin:  5um (default)

2μm

Material of Probe Pin: Diamond

Measurement Force of Probe:

4mN(0.4gf) for 5um stylus

0.75mN(0.075gf) for 2um stylus

Probe Angle: 90°

Vertical Radius of Guiding Head: 48mm

Maximum driving stroke: 17.5mm/0.7inch

Cutoff length (l): 0.25mm / 0.8mm / 2.5mm optional

Driving speed:

Vt=0.135mm/s if sampling length = 0.25mm

Vt=0.5mm/s if sampling length = 0.8mm

Vt=1mm/s if sampling length = 2.5mm

Vt=1mm/s if returning

Profile digital filter

Filtered Profile: RC

Filtered Profile: PC-RC

Filtered Profile: Gauss

Non-Filtered Profile: D-P

**1.FEATURES**

This instrument is compatible with four standards of ISO, DIN, ANSI and JIS and is widely used in production site to measure surface roughness of various machinery-processed parts, calculate corresponding parameters according to selected measuring conditions and clearly display all measurement parameters.

When measuring the roughness of a surface, the sensor is placed on the surface and then uniformly slides along the surface by driving the mechanism inside the tester. The sensor gets the surface roughness by the sharp built-in probe. This roughness causes displacement of the probe which results in change of inductive amount of induction coils so as to generate analogue signal, which is in proportion to the surface roughness at output end of phase-sensitive rectifier. The exclusive DSP processes and calculates and then outputs the measurement results on LCD.

- \* Multiple parameter measurement: Ra, Rz, Rq, Rt
- \* Highly sophisticated inductance sensor
- \* Four wave filtering methods : RC, PC-RC, GAUSS and D-P
- \* Built-in lithium ion rechargeable battery and control circuit with high capacity
- \* Can communicate with PC computer for statistics, printing and analysing by the optional cable and the software for RS232C interface.
- \* Manual or automatic shut down. The tester can be switched off by pressing the Power key at any time. On the other hand, the tester will power itself off about 5 minutes after the last key operation.

Resolution : 0.001 | m if reading 10 | m |  $\mu$   
 0.01 | m if 10 | m reading 100 | m |  $\mu$   
 0.1 | m if reading 100 | m |  $\mu$

Evaluation length :( 1~5) cut-off optional  
 Power Li-ion battery: rechargeable  
 Operating conditions: Temp. 0~50°C  
 Humidity <85%

Size: 140x57x48 mm (5.5x2.2x1.9 inch)  
 Weight: about 420 g

**Standard Accessories:**

- Carrying case .....1 pc.
- Main unit .....1 pc.
- Standard sensor.....1 pc.
- Standard sample plate.....1 pc.
- Power adapter.....1 pc.
- Operation manual .....1 pc.
- Screwdriver.....1 pc.
- Adjustable leg.....1 pc.
- Sheath of sensor.....1 pc.

**Optional accessories**

- Cable & software for RS232C
- Extension rod
- Measurement support

**3.FRONT PANEL DESCRIPTIONS AND NAMES OF EACH PARTS**

**3.1 Key descriptions**

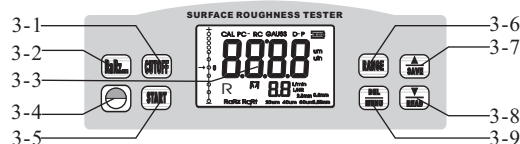

- 3-1 Cutoff
- 3-2 Parameter
- 3-3 Display
- 3-4 Power
- 3-5 Start
- 3-6 Range
- 3-7 Up/Save
- 3-8 Down/Read
- 3-9 Delete/Menu

Fig. 3-1

$$Ra = \frac{1}{n} \sum_{i=1}^n |y_i|$$

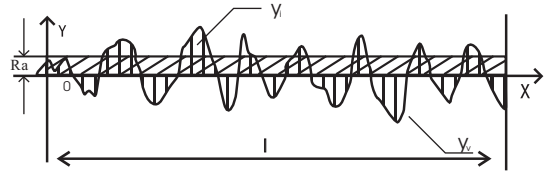

**10.4.2 Rz ten point height of irregularities**

The average of the sum of five maximum profile peaks and the average of five maximum profile valleys within the sampling length.

$$Rz = \frac{\sum_{i=1}^5 Y_i + \sum_{i=1}^5 Y_v}{5}$$

**10.4.3 Rq root-mean-square deviation of profile**

Root-mean-square of profile deviation within the sampling length, shown as the following function

$$Rq = \left( \frac{1}{n} \sum_{i=1}^n y_i^2 \right)^{\frac{1}{2}}$$

**10.4.4 Rt total peak-to-valley height**

Rt is the sum of maximum height of the profile peak and maximum depth of the profile valley for the evaluation length.

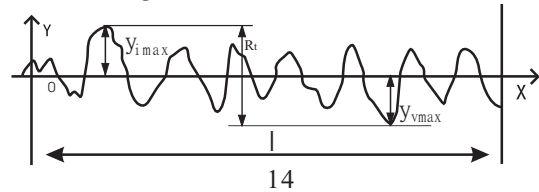

movement of the probe.

7.2.3 Use the screwdriver to adjust the resistance(3-35) and let the reading on the display close to the value of Standard sample plate.

7.2.4 Repeat 7.2.2 to 7.2.3 till the result is satisfactory.

The above procedures restore the factory settings.

7.2.5 After the factory settings, you have to calibrate the tester again. Please refer the part 6.

**8. COMMUNICATE WITH PC**

8.1 Install the optional RS232C software to the PC.

8.2 Connect the tester to the COM port of the PC with the optional RS232 cable.

8.3 Run the software on the desktop and select the COM port in the system settings.

8.4 Click the button of data collection, then click the button of Begin/Continue.

8.5 To download the groups stored in the Memory, just press the key (MEM).

**9. GENERAL MAINTENANCE**

\* Avoid crashes, intensive vibration, heavy dust, humidity, grease stains and strong magnetic fields;

\* The sensor is a precise part and should be protected carefully. It is recommended to put it back in the box after each operation;

\* Protect the standard sample plate belonging to the instrument carefully to avoid calibration faults caused by scratches.

**10. REFERENCES**

**10.1 Filter**

- a. RC filter: traditional 2-stage filter with phase difference;
- b. PC-RC filter: RC filter with phase-correction;
- c. Gauss filter: DIN4777
- d. D-P non-filtered profile: adopt central line of Least

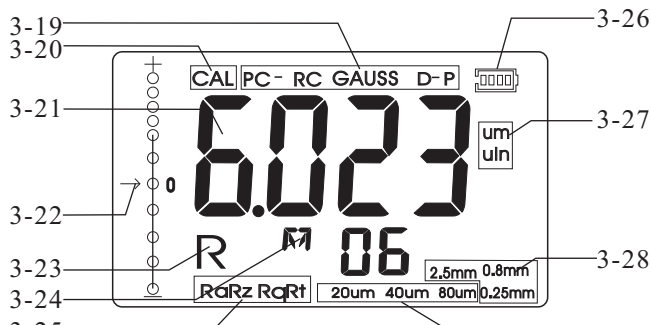

Fig. 3-5

- |                       |                 |
|-----------------------|-----------------|
| 3-19 Filter           | 3-25 Parameters |
| 3-20 Calibration      | 3-26 Battery    |
| 3-21 Measurement      | 3-27 Unit       |
| 3-22 Position pointer | 3-28 Cutoff     |
| 3-23 Browsing         | 3-29 Ranges     |
| 3-24 Memory           |                 |

### 3.3 Installation and unloading of sensor

To install, hold the main part of the sensor by hand, push it into connection sheath at the bottom of the instrument as shown in Figure 3-4 and then slightly push to the end of sheath. To unload, hold the main part of sensor or the root of protective sheath and slowly pull it out.

- The probe of the sensor is the main part of this instrument and requires close attention.
- During installation and unloading, the probe should not be touched in order to avoid damage which can affect measurement results.
- Connection of the sensor should be reliable during installation.

- Layout of connection lines should not affect measuring Part while charging.
- The meanings of battery indicators are:  
If battery voltage is normal, measurement can be carried out.  
The black part inside prompt shows capacity of Battery; Indicates too-low voltage and battery should be charged as soon as possible;  
 indicates that battery is full.
- Relative high noises of the power source can affect measurement to weak signal to some extent when battery is being charged;
- The back light of LCD will be on when charging even if the tester is still in the state of power off.  
The tester can monitor the process of charging itself.

## 4. MEASURING PROCEDURES

### 4.1 Preparations for measurement

- Switch on to test if the battery voltage is normal.
- The instrument automatically restores conditions of the last measurement before it is turned off since these conditions are automatically stored.  
Meanwhile, the second line of 2 digits on display shows the groups stored in the memory. Before taking measurement, preparations have to be made and checked.
- To check if the cutoff length selected is right. if not, Depress the to select. For the recommended cutoff length, please see the table in 10.7 on page 15.
- To check if the evaluation length selected is right.

### 4.2 Measuring

After preparations is done, just press Start key to measure if measuring conditions are not to be changed. Firstly, you will see the '---' on the display and the probe is moving forward and sampling. Then you will see the probe stop sliding and move backward. The measurement result shows on the display after the probe stop moving.

#### 4.2.1 Save the measurement results to the tester for later use

After measuring, you will see the original 'M' becomes the 'M̄'. In such a state, you can save this group of results including Ra, Rz, Rq, Rt and measurement conditions to the memory of the tester by depressing the key . Then the symbol 'M̄' changes to 'M' automatically while the number of memorized groups increases 1.

#### 4.2.2 How to browse the different parameters

In 'M̄' state, you can browse different parameters. The corresponding parameter and its value show on the display once depressing the key .

#### 4.2.3 Delete the measurement results

In 'M̄' state, you can delete this group of results by depressing the key . Then the symbol 'M̄' changes to 'M' automatically. On the other hand, the new measurement results will replace the old ones if pressing the Start key in 'M̄' state.

## 5. HOW TO BROWSE THE MEMORIZED DATA

No matter in 'M̄' state or 'M' state, you can browse the memorized data by depressing the key . The browsing state is marked in 'R' on display. When in 'R' state, you can browse different groups by depressing the key or key .

- If not, depress the key , then or to select. To save and quit, just depress the key again.
- To check if the profile filter selected is right. If not, Depressing the And not releasing it till 'FIL T' on Display. It takes about 4 seconds from starting pressing The . And then pressing key or key to cycle between RC, PC-RC, GAUSS, D-P or vice versa. To quit, just press any key other than key or key.
- To check if the measurement unit selected is right. if not, depressing the key and not releasing it till 'UNIT' on the Display. It takes about 8 seconds from starting depressing key And then pressing or to switch between the metric system and the British system. To quit, just press any key other than key or key.
- To check if the parameter selected is right. If not, depress the key to select. This step is very important.
- To clear the surface of the part to be measured;
- Refer to Figure 4-1 and Figure 4-2 to place the instrument correctly, stably and reliably on the surface to be measured.
- Refer to Figure 4-2, the sliding trail of the sensor must be vertical to the direction of process line of the measured surface.
- Adjustable leg and sheath of sensor  
When the measured surface of the part is smaller than the bottom surface of the instrument, the sheath of sensor and adjustable leg can be used for auxiliary support to complete measurement (as shown in Figure 4-3).

shows on the display. For each group, you can still browse different parameters. The corresponding parameter and its value show on the display once depressing the key (DEL MENU).

### 6. HOW TO CALIBRATE THE TESTER

- 6.1 To enter the calibration state, just depressing the Key (DEL MENU) and not releasing it till 'CAL' on the Display. It takes about 12 seconds from starting depressing (DEL MENU). The calibration state is marked by 'CAL'.
- 6.2 Take a measurement based on the Standard sample plate. Contrast the measuring value with the value of standard sample plate based on the same parameter.
- 6.3 Depress the key (SAVE) or (READ) to adjust the reading to the standard value.
- 6.4 Just repeat 6.2 to 6.3 till the accuracy is ok.
- 6.5 To quit, just press any key other than START key.
- 6.6 The instrument has been thoroughly tested before delivery to ensure that the display value error is less than  $\pm 10\%$ . The user is recommended not to use the Calibration function too often.

### 7. HOW TO RESTORE THE FACTORY SETTINGS.

- 7.1 When to restore  
It is necessary to restore the factory settings when a new probe is installed or the tester could not measure any more.
- 7.2 How to restore
  - 7.2.1 Just depressing the key (DEL MENU) and not releasing it till 'FAC' on the Display. It is about 16 seconds from starting depressing key (DEL MENU). This state is also marked by 'CAL', please see the Fig. 3-5.
  - 7.2.2 press the START key on the Standard sample plate. During the probe moves forward, you will see the different reading on the display varying with the

### 3.2 Names of each parts

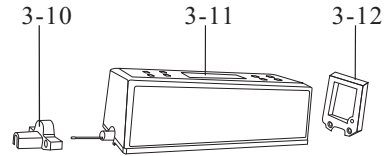

Fig. 3-2

- 3-10 Sheath of probe
- 3-11 Front panel
- 3-12 Adjustable leg

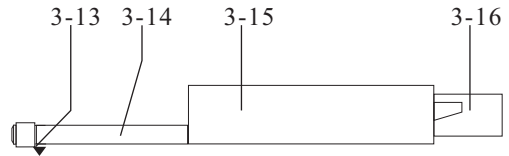

Fig. 3-3

- 3-13 Stylus
- 3-14 Protection sleeve
- 3-15 Main body
- 3-16 Socket

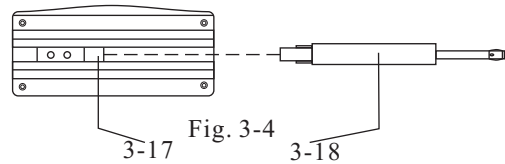

Fig. 3-4

- 3-17 Connection sheath
- 3-18 probe

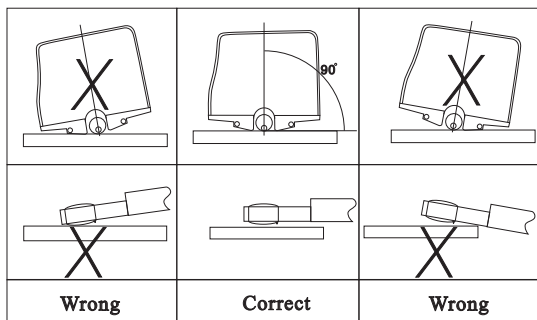

Fig. 4-1

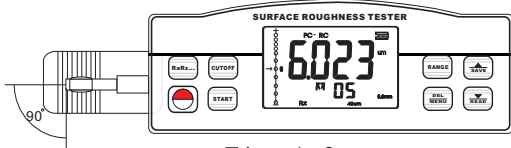

Fig. 4-2

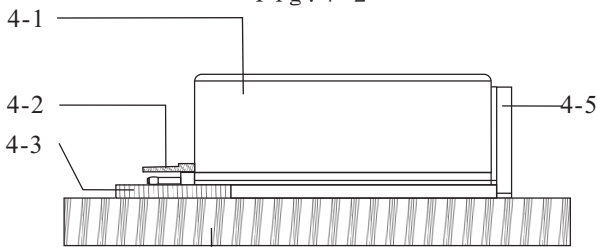

Fig. 4-3

- 4-1 Roughness tester
- 4-2 Sheath of probe
- 4-3 Item to be measured
- 4-4 Working table
- 4-5 Adjustable leg

3.4 Power adapter and charging of battery  
When the battery voltage is too low (which is indicated by the battery symbol on the screen), the instrument should be charged as soon as possible. Follow the indications shown in Figure 3-6. the power adapter should be plugged into the power socket of the instrument. The power adapter should be connected to 100~220V 50Hz and charging of the battery will begin. Input voltage for power adapter is AC 100~220V with DC 5~7V of output, about 300mA of charging current, charging time of up to 5.0 hours. This instrument uses a lithium ion chargeable battery. Charging can be fulfilled at any time without affecting the normal operation of the instrument.

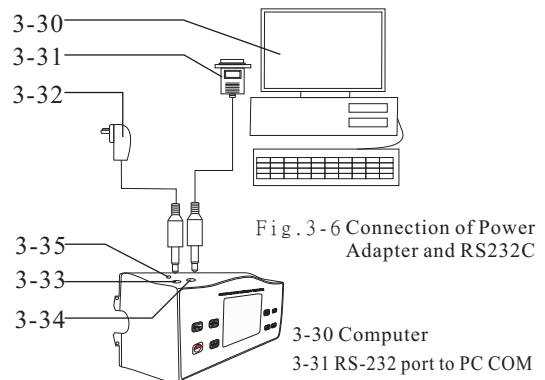

Fig. 3-6 Connection of Power Adapter and RS232C

- 3-30 Computer
- 3-31 RS-232 port to PC COM
- 3-32 Power adapter
- 3-33 DC power socket
- 3-34 RS-232 socket
- 3-35 Calibration hole

NOTES:  
See next page